

+GF+ SIGNET 8860 Dual Channel Conductivity/Resistivity Controller

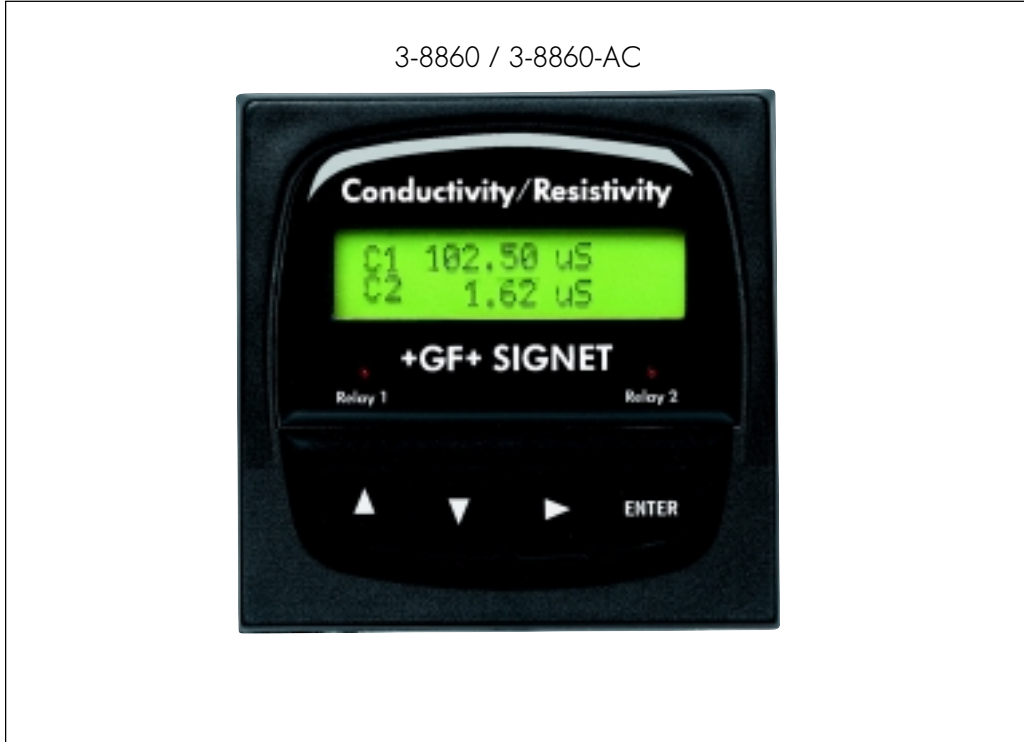

Features

- 2-Channel Input
- Simultaneous Display
- AC Line-Voltage or DC Powered
- Display and/or Control: μS , mS, PPM or PPB (TDS), $\text{k}\Omega$, $\text{M}\Omega$, % Rejection, Difference, Ratio, $^{\circ}\text{C}$ or $^{\circ}\text{F}$
- Three (3) Fully Scaleable 4 to 20 mA Outputs
- Two (2) Open Collector Outputs
- Up to Four (4) Programmable Relays
- Time Delay Relay Function
- Proportional Pulse Control Capability
- Meets USP Requirements
- Programmable Temperature Compensation
- Output Simulation for Complete System Testing
- Simple Push-button Operation
- 1/4 DIN, NEMA 4X/IP65 Enclosure with Self-healing Window

Description

The +GF+ SIGNET SIGNET 8860 Dual Channel Conductivity/Resistivity Controller is a two-channel input device equipped with three scaleable 4 to 20 mA outputs and four programmable relays. A selector switch activates two open collector outputs in place of two of the relays for extraordinary output versatility. Dual input and advanced control capability, including percent rejection, difference and ratio calculations, together with the +GF+ SIGNET

Conductivity Electrodes listed below, form the perfect measurement and control system for water treatment applications and more. Two versions are available: one accepts AC line-voltage, the other low voltage DC for power. The four-button keypad arrangement with intuitive software design is user-friendly, and the NEMA 4X/IP65 integrity of the front panel can be extended to the entire enclosure by using the optional Rear Cover Kit.

Technical Features

	Part No.	Power Requirement	Sensor Input	4 to 20 mA Output	Open Collector/Relay Output
	3-8860	12 - 24 VDC $\pm 10\%$	2	Three (3) for: Conductivity/Resistivity, Temperature, % Rejection, Difference, Ratio	4 Relays or (switch selectable) 2 Open Collectors and 2 Relays
	3-8860-AC	100-240 VAC $\pm 10\%$ 50 - 60 Hz or 12 - 24 VDC $\pm 10\%$	2	Three (3) for: Conductivity/Resistivity, Temperature, % Rejection, Difference, Ratio	4 Relays or (switch selectable) 2 Open Collectors and 2 Relays

Application

- RO/DI System Control
- Demineralizer Regeneration and Rinse
- Scrubber, Cooling Tower & Boiler Protection
- Chemical Concentration
- Rinse Tank Water Quality
- Desalinization
- Leak Detection
- Aquatic Animal Life Support Systems
- Aquaculture
- Environmental Studies

Options

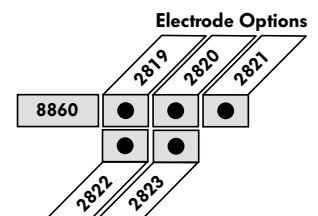

Dimensions

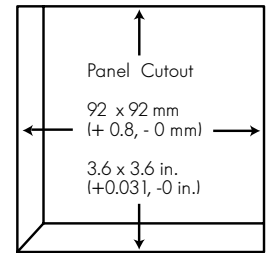
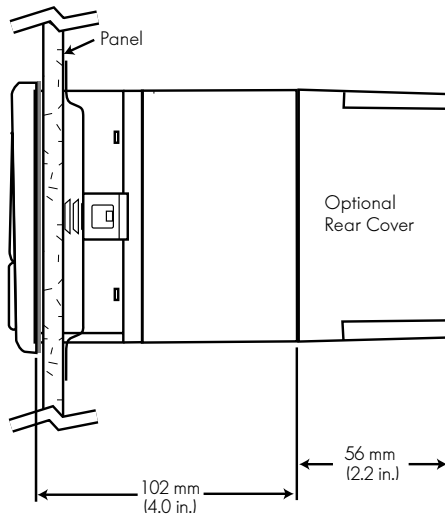
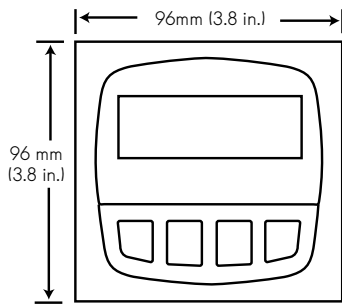

Installation

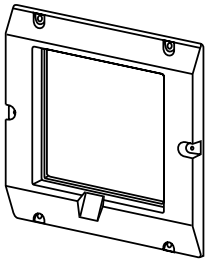

- Optional 5x5 inch Adapter Plate for SIGNET retrofit (3-5000.399)

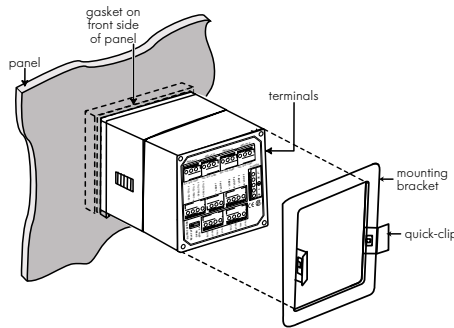

- Panel Mounting Bracket and Panel Gasket are included

- Front panel provides NEMA 4X/IP65 protection
- Standard 1/4 DIN panel cutout
- 102 mm (4 in.) mounting depth
- Optional NEMA 4X/IP65 rear cover kit with knockout ports for cable access
- 158 mm (6.3 in.) mounting depth with optional rear cover installed

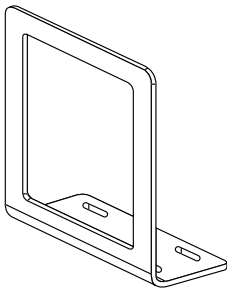

- Optional Surface Mounting Bracket (3-5000.598)

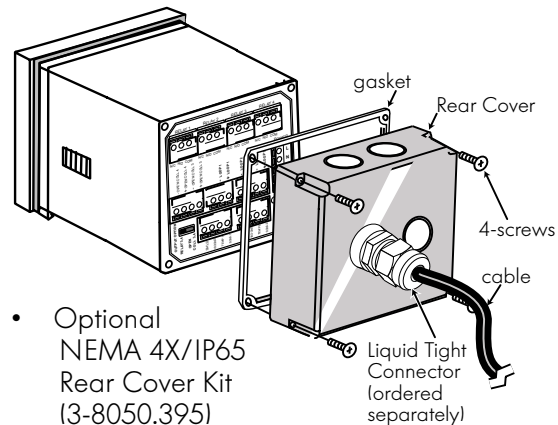

- Optional NEMA 4X/IP65 Rear Cover Kit (3-8050.395)

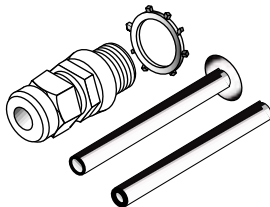

- Liquid Tight Connector Kit (3-9000.392 - 3 sets per kit) (3-9000.392-1 - 1 set per kit) Use with optional NEMA 4X/ IP65 Rear Cover Kit.

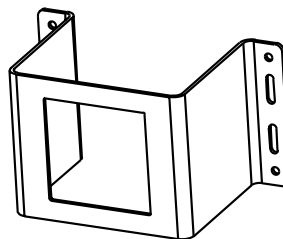

- Optional Heavy-Duty Wall Mount Bracket (3-0000.596)

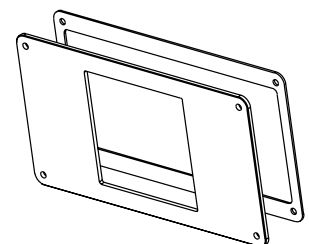

- Optional 200 Retrofit Adapter (3-8050.392)

Rear Terminal View

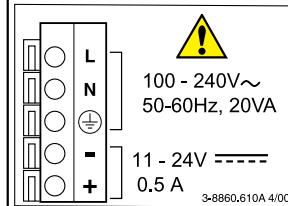
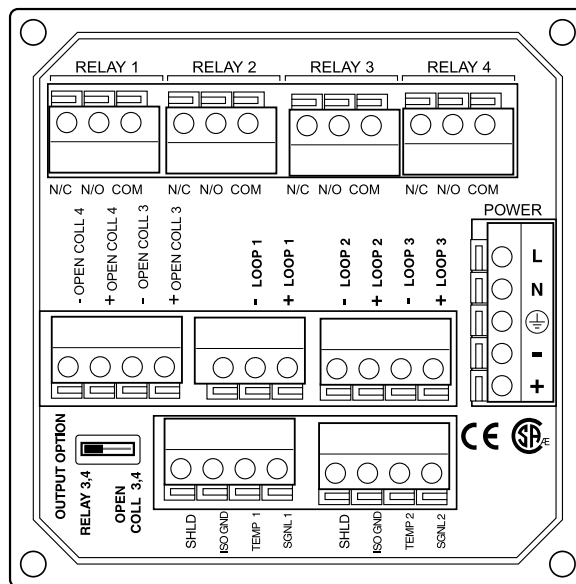

NOTE: This label appears on the side of the instrument case.

Technical Data

General

Compatible Electrodes: +GF+ SIGNET 3-28XX
Standard or Certified NIST Conductivity/Resistivity Electrodes

Operating Range:

Conductivity: 0.055 to 400,000 $\mu\text{S}/\text{cm}$
Resistivity: 10 $\text{K}\Omega/\text{cm}$ to 18.26 $\text{M}\Omega/\text{cm}$
(0.055 to 100 $\mu\text{S}/\text{cm}$)
TDS: 0.001 to 999999 ppm or ppb (display limit)
Temperature: PT 1000: -25 to 120°C
(-13 to 248°F)

Accuracy:

Conductivity/Resistivity: $\pm 2\%$ of reading
Temperature: $\pm 0.5^\circ\text{C}$

Power Requirements:

3-8860-AC: 100 to 240 VAC $\pm 10\%$,
50-60 Hz, 20VA
3-8860: 11 to 24 VDC $\pm 10\%$,
reg., 0.5A max.

Display: Alphanumeric 2 x 16 LCD
Contrast: User selected, 5 levels
Update rate: 1.5 seconds

Current outputs: (3 each) 4 to 20 mA, isolated, fully adjustable and reversible

Max. loop impedance: 150 Ω @ 12 V
450 Ω @ 18 V
750 Ω @ 24 V

Update rate: Approx. 100 mS
Accuracy: ± 0.03 mA @ 25°C, 24 VDC

Open-collector outputs: (2 each) Isolated, 50 mA sink or source, 30 VDC max. pull-up voltage

Operational Settings: Hi, Lo, USP, Pulse, Off
Hysteresis: User adjustable

Time Delay: 0 to 6400 seconds
Maximum Pulse Rate: 400 pulses/minute

Alarm Contacts: (up to 4 each) SPDT Relays

Max. voltage ratings: 5 A @ 30 VDC or
5 A @ 250 VAC

Operational Settings: Hi, Lo, USP, Pulse, Off

Hysteresis: User adjustable
Time Delay: 0 to 6400 seconds

Maximum Pulse Rate: 400 pulses/minute

Enclosure

Rating: NEMA 4X/IP65 front and back with optional NEMA 4X Rear Cover Kit

Materials:

Case: PBT
Window: Polyurethane coated polycarbonate

Keypad: Sealed 4-key silicone rubber

Shipping Weight:

8860-AC: Approx. 0.581 kg (1.3 lbs.)
8860: Approx. 0.544 kg (1.2 lbs.)

Environmental

- Ambient operating temp: -10 to 55°C (14 to 131°F)
- Storage temperature: 15 to 80°C (5 to 176°F)
- Relative humidity: 0 to 95%, non-condensing
- Max. Altitude: 2000m (6,560 ft.)

Standards and Approvals

- CSA, CE, UL
- Immunity: EN50082-2
- Emissions: EN55011
- Safety: EN61010
- Manufactured under ISO 9001 and ISO 14001

Ordering Information

Mfr. Part No.	Code	Description
3-8860	159 000 677	Conductivity/Resistivity Controller, DC Powered
3-8860-AC	159 000 678	Conductivity/Resistivity Controller, AC Powered

Accessories

Mfr. Part No.	Code	Description
3-8050.395	159 000 186	NEMA 4X/IP65 Rear Cover
3-8050.392	159 000 640	Model 200 Retrofit Adapter
3-5000.399	198 840 224	5x5 inch Adapter Plate for +GF+ SIGNET retrofit
3-0000.596	159 000 641	Heavy Duty Wall Mount Bracket
3-5000.598	198 840 225	Surface Mount Bracket
3-8050.396	159 000 617	RC Filter Kit (for relay use)
3-9000.392	159 000 368	Liquid-tight Connector Kit for rear cover (includes 3 connectors)
3-9000.392-1	159 000 839	Liquid tight connector (1 set), NPT
3-9000.392-2	159 000 841	Liquid tight connector (1 set), pg 13.5
3-2830	159 000 628	Conductivity Certification Tool

Engineering Specifications

- The conductivity/resistivity controller shall have 2-channel input.
- The conductivity/resistivity controller shall be powered by AC line-voltage or 12 to 24 VDC.
- The conductivity/resistivity controller shall display and/or control: μS , mS , PPM or PPB (TDS), $\text{k}\Omega$, $\text{M}\Omega$, % Rejection, Difference, Ratio, $^{\circ}\text{C}$ or $^{\circ}\text{F}$.
- The conductivity/resistivity controller shall provide three (3) fully scaleable 4 to 20mA outputs.
- The conductivity/resistivity controller shall provide two (2) open collector outputs.
- The conductivity/resistivity controller shall provide up to four (4) programmable relays.
- The conductivity/resistivity controller shall provide time delay relay functionality.
- The conductivity/resistivity controller shall provide proportional pulse control capability.
- The conductivity/resistivity controller shall meet USP requirements.
- The conductivity/resistivity controller shall provide programmable temperature compensation.
- The conductivity/resistivity controller shall provide output simulation for complete system testing.
- The conductivity/resistivity controller shall be 1/4 DIN and sealed to NEMA 4X/IP65 requirements.
- The conductivity/resistivity controller display shall be protected with a self-healing window.
- The conductivity/resistivity controller shall be +GF+ SIGNET 8860 Dual Channel Conductivity/Resistivity Controller