

# weber foto-captor

Engineered Solutions

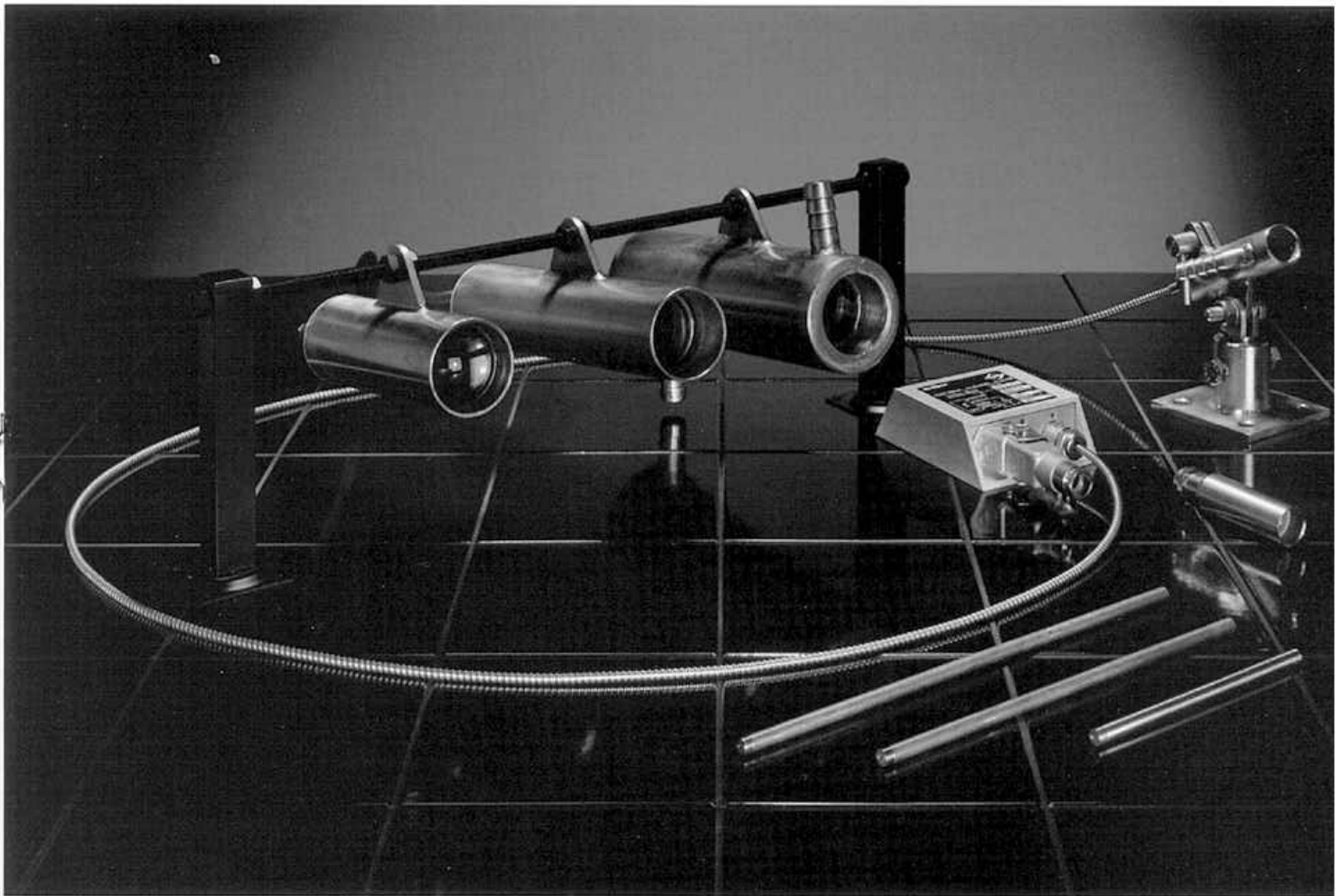

## The remarkable foto-captor

is the leading hot product sensor throughout the world's steel industry. Its highly advanced infrared radiation technology and design concept serve sophisticated industrial systems in metal manufacturing, heat treatment and glass making.

With more than 25 years of experience, our foto-captors are produced for tough, demanding industries and guaranteed by our commitment to supply high accuracy, long-life reliability and dependable performance with each one of our maintenance-free sensors, even in the harshest environments.

Well respected throughout the industry as problem solvers in infrared detection, we developed a wide range of foto-captor types with various response temperatures, remote lens systems, fibre optic cables, cooling jackets, air purges and other smart accessories to accommodate many different applications in hot product detection.

The foto-captors are compensated for high ambient temperatures and don't require adjustment. The highly selective viewing fields and temperature set-points prevent signaling outside these parameters.

Because your environment is our home, we are devoted to the continuing development of user-oriented infrared sensors for process control and are proud to be unsurpassed. This, however, was only possible as a result of the vigorous co-operation with a wide range of respected customers. Our customers requirements keep our research and development abreast and provide the stimuli for the future.

# foto-captor Hot Product Detector

## Application

The **foto-captor**, hot metal detector, is an infrared switch especially designed for fault-free operation in the harsh environments of heavy industry. For more than 25 years **foto-captors** have been successfully installed to monitor hot products in:

- Rolling mills

to control cut to length shearing, monitor hot rods, controlling roller tables, coil regulating, switching in crosscut hauler, monitor de-scaler, cooling beds, winder control, monitor edge washing, continuous casting or tracking of high speed wire.

- Coke ovens

to monitor quenching, cutting off press, monitoring exhaust gas flare and conveyors in ovens.

- Forges and Foundries

to monitor pouring and casting processes, position control.

- Refuse Incinerators

to monitor oven conveyor belt.

- Blast Furnaces

waste monitoring

- Glassworks

to monitor mould and stamping dies.

- General Industry

wherever infrared radiation requires a reliable signal.

## Principle of Operation

The infrared radiation, received through the lens system, is transmitted to an IR detector. When the radiation exceeds a trigger point, the electrical switching output is activated.

The special **foto-captor** electronic circuitry compensates for ambient temperature changes and component aging. Adjustment is therefore not necessary, thus providing higher operational safety and reliability. Three different set-point temperatures provide optimal temperature responses.

## Typical Applications

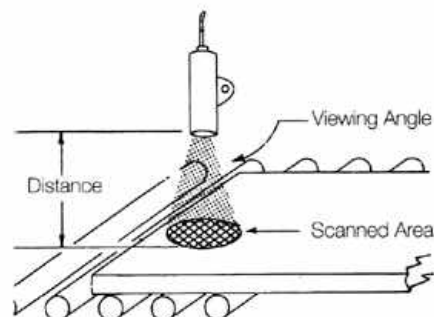

The above sketch indicates a typical application in a slab mill. The viewing angle determines the scanned area.

**For example:** if a **foto-captor** type 1331.-- is installed at a viewing distance of 2 m, the scanned area has a diameter of 28 cm. **foto-captor** type 1331.-- has a set-point temperature of 450 °C. Therefore hot steel, at 450 °C must cover the entire area before the **foto-captor** switches. If hot product exceeds 450 °C, less of the scanned area needs to be filled to get a switching signal, (see temperature response diagram).

## Design Feature

**foto-captors** are rugged infrared switches completely epoxy resin encapsulated in stainless steel housings. **foto-captors** are designed to be impervious to the effects of steam, water, dust, shock, vibration and oily conditions associated with heavy industrial environments. They are temperature compensated for extreme ambient temperature conditions. **foto-captors** are available with an inbuilt test circuit to provide a pre-check prior to actual monitoring of hot product (as required for computer controlled production processes). **foto-captors** are available as integral units or with remote fibre optic lens systems. For very high ambient temperatures **foto-captors** may be supplied with cooling jackets for water or air cooling. If ambient air is influenced by dust or steam, housings are available with an air purge to enable the lens to be freed from obstructions with compressed air.

A special swivel stand is available which allows free movement on all 3 axes.

## foto-captor Type Code

**foto-captors** are available with different temperature ranges, viewing angles, housings, cooling jackets and electrical outputs. They are supplied with and without fibre optics, integral or remote lens systems.

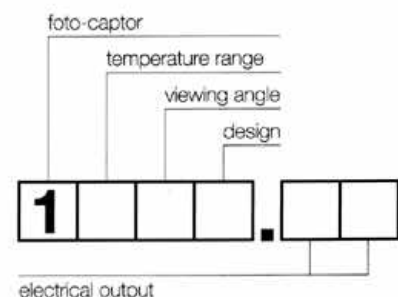

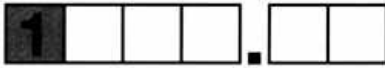

### Technical Data

Type (see type-code)	11 ---	12 ---	13 ---	14 ---
Ambient temperature	- 30 °C to +45 °C	- 30 °C to +55 °C	- 30 °C to +75 °C	- 30 °C to +85 °C
Housing with or without cooling jacket	1.4541 stainless steel tube			
Construction	all parts & components encapsulated			
Shock and vibration	in accordance with DIN 57 411			
Protection standard	IP 65 / DIN 400 50			
Function indicator: green LED	off: without IR radiation contact			
Exception ----,63	on: without IR radiation contact			
Overload indicator	red LED			
Electrical connection	moulded armoured silicone cable or connection socket			
cable length	standard 2 m			
Mass	see dimension diagram			
Test function	standard for type 1-07,---, for compact types see "foto-captor Design"			

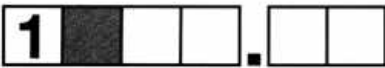

### Set-point Temperature

Min. temperature response	270-300 °C*	350 °C	450 °C	800 °C
Type	11 --	12 --	13 --	14 --

\* dependent on the type



### Optical Data

Type	1-1-..	1-2-..	1-3-..	1-4-.. V*/S* S100	1-4-.. V*/S* S102	1-4-.. V*/S*	1-6-..	1-7-..	1-8-..
Viewing angle	1°	2°	7°	1°x7°	1°x15°	2°x25°	25°	12°*	1/2°
Scanned area (in cm) at 2m distance	4 ø	8 ø	28 ø	4x28	4x60	8x100	100 ø	FOC*	2 ø

V\* = vertical S\* = horizontal FOC\* = standard length 2m, s. table FOC 12°\* = usable angle



### foto-captor Design

Test circuit					●	●	●	●
Cooling jacket		●		●		●		●
Cable	●	●			●	●		
Socket			●	●			●	●
Type	1--1.	1--2.	1--3.	1--4.	1--5.	1--6.	1--7.	1--8.

Optional: air purge 1---,---L

### Scanned Area at Various Distances. Chart A

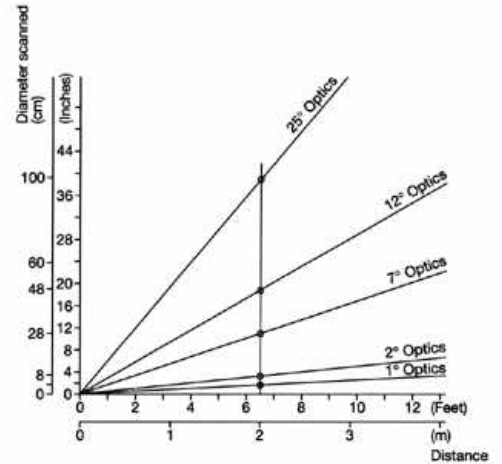

### Temperature Response Curve Chart B

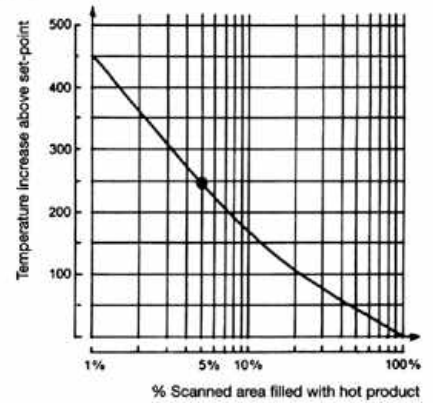
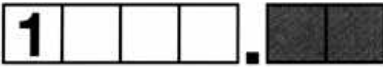

Chart B illustrates the increase in set-point temperature required to operate the **foto-captor** relative to the percentage of the scanned area containing the hot product.

**Example:**  
**foto-captor** type 1331.-- response temperature, when scanned area is covered, 100% by hot product. = 450 °C

However, if only 5% of scanned area contains hot product the **foto-captor** requires an additional (from chart above): 250 °C  
 Set-point temperature: + 450 °C  
 Effective response temperature is therefore: = 700 °C



## Electrical Data

	AC				DC					
	thyristor output		relay output		transistor antivalent output		optocoupler output		relay output	
Output type	----.62	----.63	----.80	----.81	----.14	----.15	----.42	----.43	----.40	----.41
Output logic*	n.c.	n.o.	n.c.	n.o.	PNP n.o. NPN n.c.	PNP n.c. NPN n.o.	n.c.	n.o.	n.c.	n.o.
Supply voltage	98 - 122 V or 196 - 244 V				20 - 27 V					
Max. load current	200 mA		250 V AC / 30 V DC 2 A resistive load		500 mA		30 V / 50 mA R <sub>i</sub> = 240 Ω		250 V AC / 30 V DC 2 A resistive load	
Min. load current	20 mA		—		—		—		—	
Leakage current	5 mA		—		—		—		—	
Current consumption	—		40 mA		15 mA		15 mA		40 mA	
Switching frequency	20 Hz		50 Hz		1000 Hz		1000 Hz		50 Hz	
Switching delay activation	10 ms	1 ms	2 ms	4 ms	0,6 ms		0.2 ms		2 ms	4 ms
Switching delay release	1 ms	10 ms	4 ms	2 ms	0,6 ms		0.2 ms		4 ms	2 ms
Trip point for overload, SCP	approx. 275 mA		—		approx. 600 mA		—		—	
Voltage drop	12 V		—		2 V		acc. to load current		—	

\* n.c.: output status without IR radiation contact      n.c.: normally closed  
n.o.: normally open

## Test Circuit

Internal voltage supply	115 V	230 V	24 V	24 V	24 V
Current consumption	22 mA	11 mA	30 mA	30 mA	30 mA

## Connection Diagrams

AC thyristor output

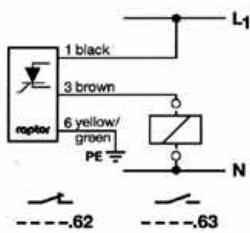

AC relay output

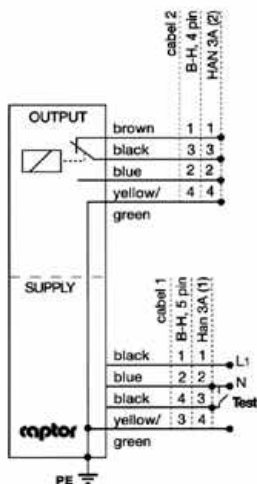

DC transistor antivalent output

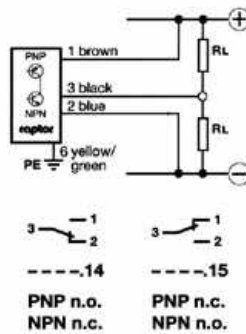

DC optocoupler output

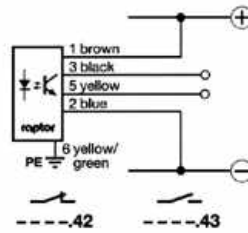

DC with relay output

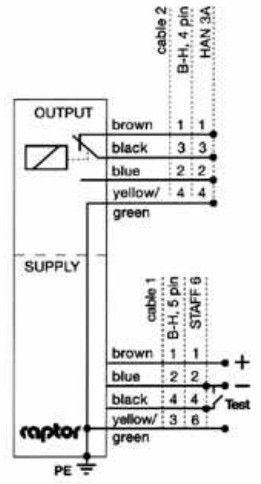

AC test circuit

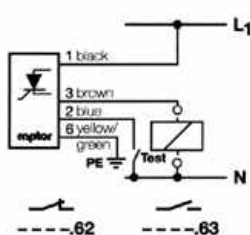

Relay without IR-detection

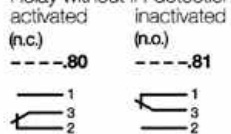

DC test circuit

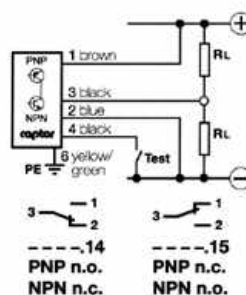

DC test circuit

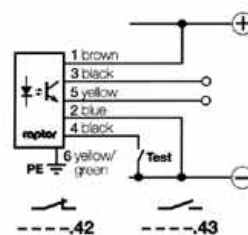

Relay without IR-detection

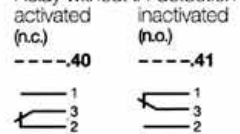

- Interchangeable Lens and Fibre Optic Cable (FOC)
- IR Test Circuit
- Optical Test of FOC
- Simple to install
- Remote mounting of electronics

## Design Features

The use of fibre optic cables enables mounting of the electronic unit at a distance from the high temperature area. This has the advantage of allowing detection of IR-radiation of hot material from close range.

The following design variations are available for such cases:

No	Variant	Ambient temp.
1	Lens in standard housing	max. +85 °C
2	Lens in special housing (e.g. 1003 H)	max. +200 °C
3	Lens in housing with cooling jacket (dependent on coolant flow)	max. +400 °C
4	IR-FOC	max. +400 °C
5	Quartz rod	max. +450 °C

## Infrared Test Function

The IR test function activates an inbuilt IR beam, thus testing the **foto-captor** function. This test is of special advantage e.g., where microprocessors have the test function of the **foto-captor** incorporated in their program.

## Optical Test of Fibre Optic Cable

Because of mechanical stress it is possible that individual fibres in the optic cable break. This results in a gradual deterioration of the signal.

Utilizing the IR test function, it is possible to visually inspect the optic cable and check the individual fibres.

## Fibre Optic Cable (FOC)

Length	2 m	3 m	4 m	5 m
IR-FOC (up to 400 °C)	1042	1043	1044	1045

Other lengths on request.

Notes:

Response temp. with IR-FOC increases by 30 °C/m for lengths greater than 2 m.

## Quartz Rod

Length	100 mm (other lengths on request)
Viewing angle	12° usable
Covered area at 50 cm distance	12 cm ø
Ambient temperature	max. +450 °C
Quartz rod housing	Type 100
Quartz rod housing with air purge	Type 100 L

## Remote Lens

Viewing angle	1°	2°	7°	1° x 7°	1° x 15°	2° x 25°	25°	1/2°
Scanned area in cm at 2 m distance	4 ø	8 ø	28 ø	4 x 28	4 x 60	8 x 100	100 ø	2 ø
Lens type (up to +85 °C ambient temperature)	1001	1002 10023	1003	1004 V* S100	1004 V* S102	1004 V* 1004 S*	1006	1008
Lens type (up to +200 °C ambient temperature)			1003 HS	10043 V* HS S100				

Add. type code:

K = cooling jacket

L = flange

LL = flange, air purge

H = high temp.

HS = high temp., protection glass

S1-- = special type

V\* = vertical detection

(i.e. 7° vertical, 1° horizontal), construction ⊕

S\* = horizontal detection

(i.e. 7° horizontal, 1° vertical), construction ⊕

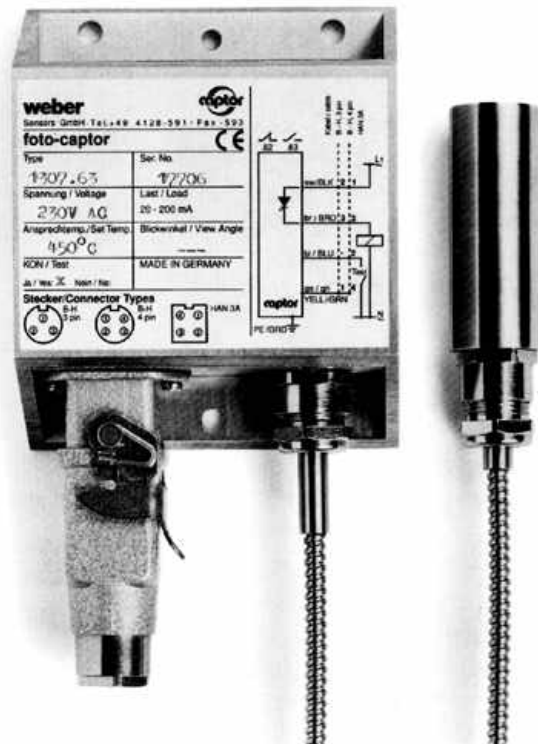

**foto-captor** Type 1207.--/1307.--/1407.-- with interchangeable remote lens system

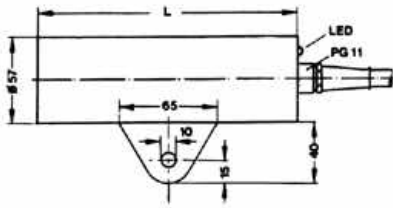

Type	Length (L)	Mass
1-1-,-	252 mm	3.0 kg
1-2-,-	172 mm	1.0 kg
1-3-,-	172 mm	1.0 kg
1-4-,-	172 mm	1.4 kg
1-4-,- S100	252 mm	3.0 kg
1-4-,- S102	252 mm	3.0 kg
1-7-,-	172 mm	1.5 kg
1-8-,-	352 mm	3.4 kg

Available versions with standard housing:  
1--1-,- ; 1--3-,- ; 1--5-,- ; 1--7-,-

### Standard Housing

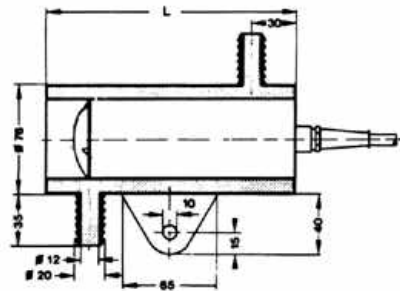

Type	Length (L)	Mass
1-1-,-	252 mm	4.2 kg
1-2-,-	172 mm	1.9 kg
1-3-,-	172 mm	1.9 kg
1-4-,-	172 mm	2.3 kg
1-4-,- S100	252 mm	4.2 kg
1-4-,- S102	252 mm	4.2 kg
1-7-,-	172 mm	2.4 kg
1-8-,-	352 mm	5.5 kg

Available versions with cooling jacket:  
1--2-,- ; 1--4-,- ; 1--6-,- ; 1--8-,-

### Cooling Jacket

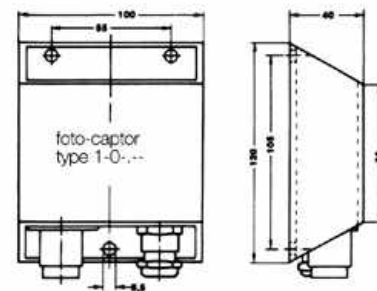

mass: 0.85 kg

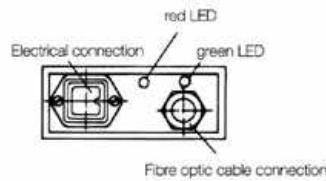

### Electronics Unit



Type	Length (L)	Mass
10023	90 mm	250 g
1003	65 mm	200 g
1003 HS	65 mm	250 g

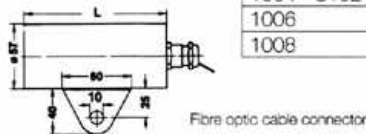
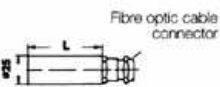

Type	Length (L)	Mass
1001	172 mm	800 g
1002	122 mm	700 g
1004-	122 mm	600 g
1004- S100	172 mm	1000 g
1004- S102	172 mm	1100 g
1006	122 mm	500 g
1008	252 mm	1100 g

### Remote Lens



The different remote lenses are also available with cooling jacket housing, type e.g. 1002 K

### Swivel Stand

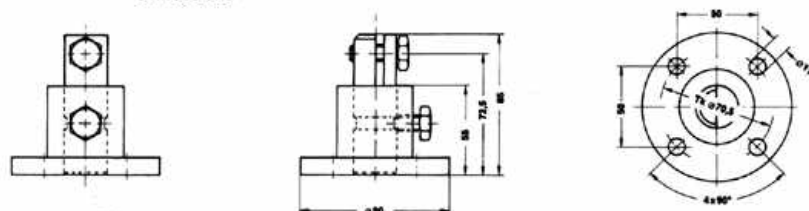

mass: 1.20 kg

### Swivel Stand



**weber**

Sensors GmbH · Strohdreich 32 · D-25377 Kollmar · Tel.: +49 4128-591 · Fax: -593

Sensors Ltd · 4 Union Street · Southport · Merseyside PR9 0QE · UK · Tel.: +44 1704-548706 · Fax: -533956

Sensors Inc · 2230 Towne Lake Pkwy., Bldg.900, Suite 200 · Woodstock, GA 30189 · Tel.: +1(770)592-6630 · Fax: -6640